



Specialist for Pumping Technology

INNOVATION
EFFICIENCY
QUALITY



PS

Single Stage Horizontal Centrifugal Pump

For more than 60 years the name Ruhrpumpen™ has been synonymous worldwide with innovation and reliability for pumping technology

Ruhrpumpen is an innovative and efficient centrifugal pump company that offers operators of Pump systems a wide range of quality products. Ruhrpumpen is committed to worldwide excellence, with a complete range of pumps to support core markets, such as Petrochemical, Oil & Gas, Power, Heavy Industry Applications, Mining, and Water. Our broad product line complies with the most demanding quality standards and industry specifications such as: API, ANSI and Hydraulic Institute Standards.

Ruhrpumpen is a vertically integrated company with its own foundry, machine shop, pump manufacturing plants and service centers. With strategically located manufacturing plants, operating offices and service centers in many parts of the world, Ruhrpumpen truly is a global pump company which also has the strength to focus on the local necessities of each client.

Characteristics

- 1 Single stage horizontal centrifugal pump.
- 2 Vertical split casing, foot mounted.
- 3 End suction, vertical discharge on the center line.
- 4 Clockwise rotation viewed from coupling end.

Description

STANDARD CONSTRUCTION MATERIALS

- All Cast Iron.
- All in 316 stainless steel.
- Cast Iron with 316 stainless steel internals.

BROAD APPLICATION RANGE

- The PS pump is suitable for up to 6% paper stock as well as water and other liquids found in all Industrial Applications.
- Mining
- Steel
- Chemical and food process applications.

DESIGN

- Oil lubricated bearings
- Flange Connections
- Back pull out allows ease of disassembly without disturbing piping.
- Wear plate is bolted at 3 points (easier to remove)
- Provided at impeller suction side to protect casing against wear. Easily renewable in the field.

Performance Range

PERFORMANCE DATA

Capacity	up to 1,817 m ³ /h	up to 8,000 gpm
Head	up to 91 m	up to 300 ft
Pressure	up to 10.6 kg/cm ²	up to 150 psi
Temperature	up to 144 °C	up to 300 °F
Speed	740 to 1420 min ⁻¹	860 to 1750 rpm

Note: For pump operations outside this range, please contact a Ruhrpumpen Representative.

Selection Chart PS

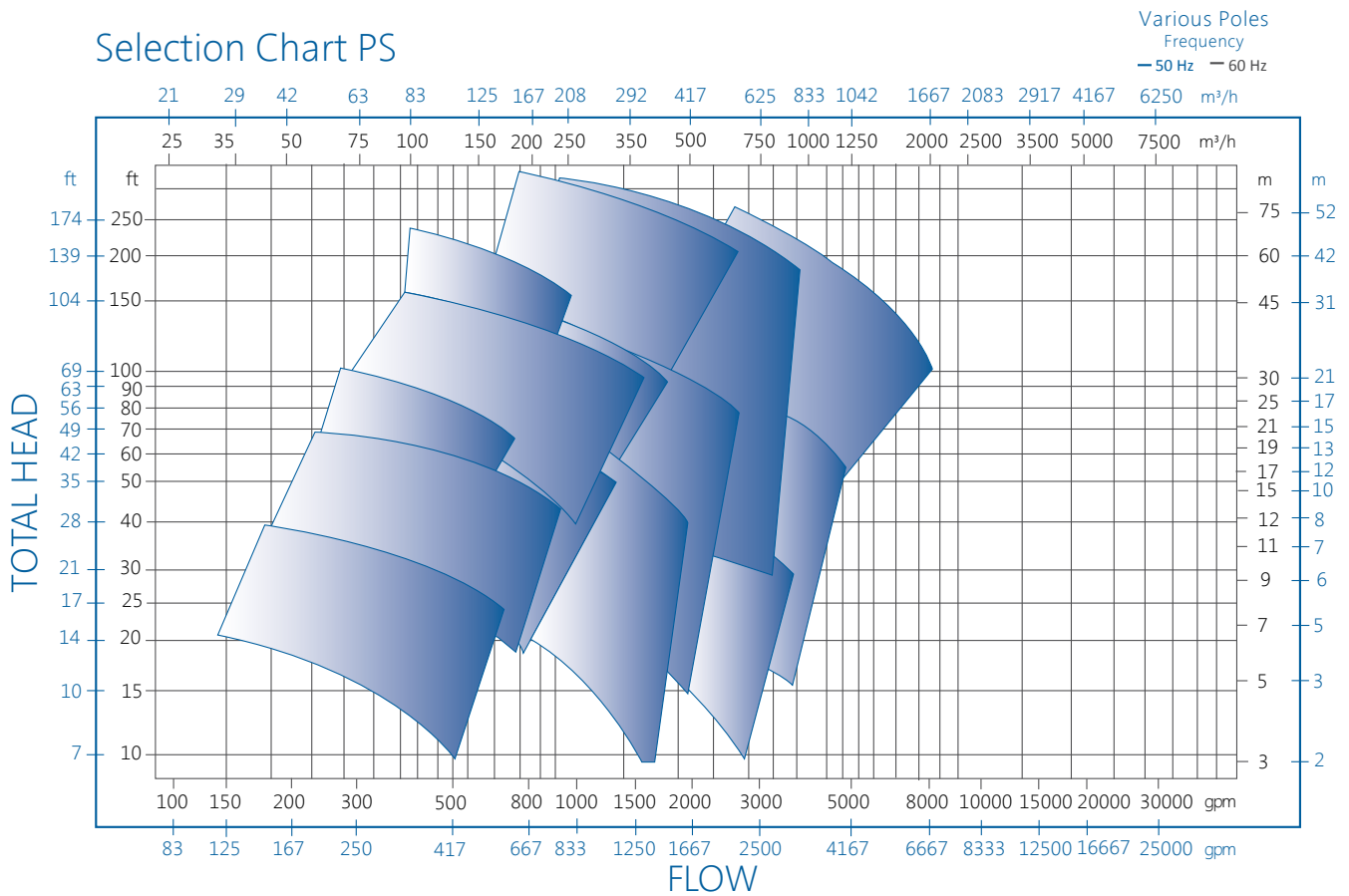

PS

Dimensions

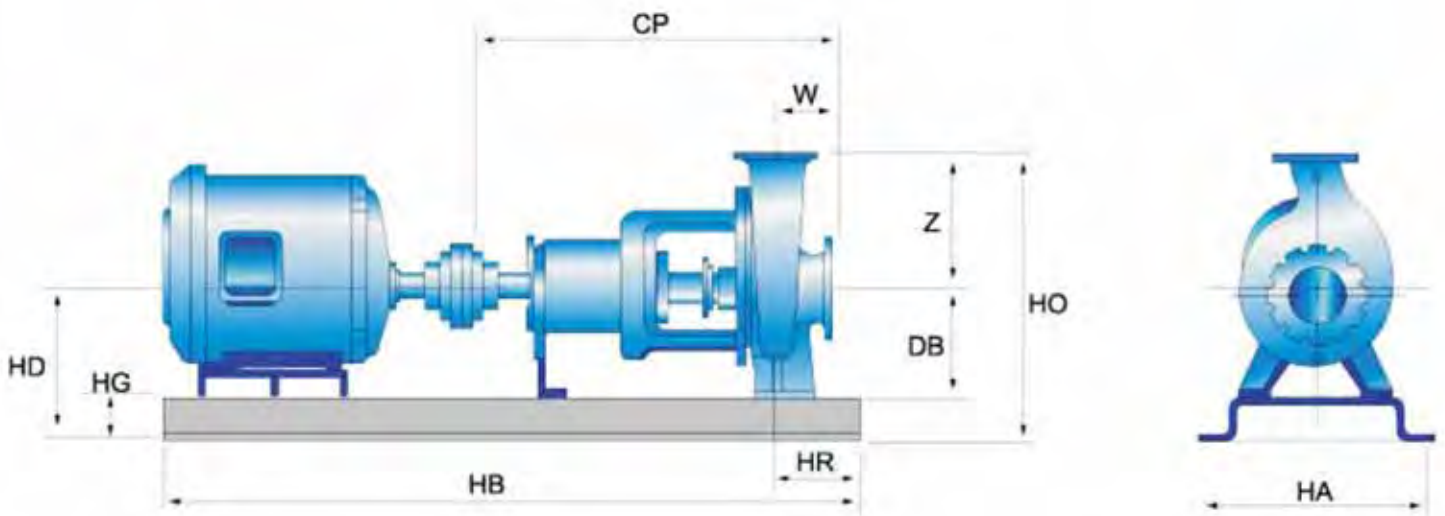

MODEL	CP	W	Z	DB	HO	HD	HR	HA	HB	HG
3PSB - 141	27.5	5.0	14.2	10	31	17	3	27	56	4.0
4PS - 121	30.1	7.4	15.5	10	33	17.2	3	27	56	4.0
4PS - 161	43.6	8.8	17.7	10	39	21.2	3	30	80	4.0
6PS - 172	44.1	8.9	23	14	41.6	21.2	3	30	80	4.0
8PS - 172	46	10.7	25	16.7	48.2	23.7	3	37	80	4.0

Other Ruhrpumpen Products

Horizontal Split Case Multi-Stage Pump

Heavy-duty process pump, two and four stage, double volute, side-side nozzle, enclosed impeller. High pressure applications such as Boiler Feed. Petrochemical, Chemical Industrial and Power Plants.



Volute Casing Centrifugal Pump

Axially split, horizontal single or double stage, double volute casing, double suction, radial, closed impeller. Heavy duty process design according to API 610 latest edition (type BB1). Pipeline Service-Mainline and Booster, Oil Extraction, Refinery, Chemical, Petrochemical, Metallurgical and Power Stations.

ANSI Horizontal Process Pump

Single stage, radially split casing with flanged connections, enclosed impeller, foot mounted. Petrochemical, Oil & Gas, Steel Industry, Automotive, Power Generation, Water Treatment, Pharmaceutical and General Process.



Vertical Barrel Pump







Low NPSH "Shockless Entry" first stage impeller (single or double suction), Single or multi-stage. Standard construction materials according to API latest edition (type VS6). Condensate, Power Plants, Municipal, Hydrocarbons, Pipeline and Refineries.



With every project you can count on **QUALITY, SERVICE, EXPERTISE, INNOVATION** and **COMPETITIVENESS**.
Because we have a commitment to each customer, the community, and the world.
We are Ruhrpumpen, the specialist for pumping technology!



RUHRPUMPEN PLANTS

-  GERMANY, Witten
-  USA, Tulsa & Orland
-  MEXICO, Monterrey
-  EGYPT, Cairo
-  INDIA, Chennai
-  BRAZIL, Rio de Janeiro
-  ARGENTINA, Buenos Aires

More Information:

